

ROUTINE

SUB110 SP

Self-powered subwoofer

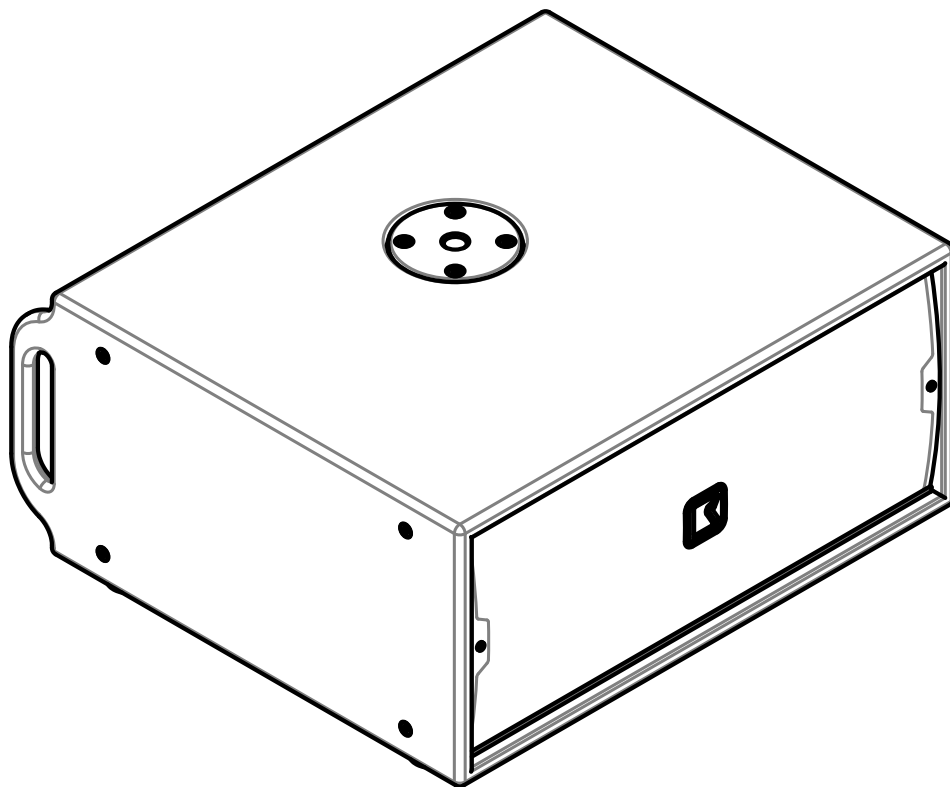

USER MANUAL

SAFETY REGULATIONS



Please read this manual carefully and in its entirety. It contains important information regarding safety issues, including guidelines for general safe use of rigging systems as well as advisories on government regulations and liability laws. The suspension of large, heavy objects in public places is subject to numerous laws and regulations at the

national/federal, state/provincial, and local levels. The user must assume the responsibility for making sure that the use of any rigging system and its components in any particular circumstance or venue conform to all applicable laws and regulations in force at the time.

GENERAL SAFETY RULES

- Carefully read this manual in all its parts
- Respect the working load limits and maximum configurations of the elements and of any third-party component (such as suspension points, motors, rigging accessories, etc...)
- Do not incorporate any accessory not provided by Outline; all damaged or defective components must be replaced only by equivalent parts approved by Outline
- Ensure personnel health and safety, ensure that no one is standing under the system during the installation, ensure that all personnel involved in the installation are equipped with personal safety devices
- Always double check that the elements are correctly connected before suspending the system.

DISPOSAL OF WASTE MATERIALS

 Your product is designed and manufactured with high quality materials and components,  which can be recycled and reused. When this crossed-out wheeled bin symbol is attached to a product, it means the product is covered by the European Directive 2012/19/EU and subsequent amendments. This means that the product must NOT be disposed of with other household-type waste. It is

the users' responsibility to dispose of their waste electrical and electronic equipment by handing it over to an approved reprocessor. For more information about where you can send your equipment for recycling, please contact your local distributor. The correct disposal of your old product will help prevent potential negative consequences for the environment and human health.

CONFORMITY AND WARRANTY

 All the Outline electro-acoustic and electronic devices are in conformity with the provisions of EC/EU directives (as stated in our CE declaration of conformity).

The CE declaration of conformity is attached to the product warranty certificate and is shipped with the product.

SYSTEM DESCRIPTION

SUB110 is a subwoofer system for low frequencies reproduction. Single-way, high power, short throw.

The cabinet is constructed with high quality baltic birch plywood with black polyurea coating and a sturdy grill. The compact nature of this cabinet allows installation within the tightest of places, it can be easily tucked under bench seating.

Based on a dual-port band-pass design and utilising a single 10" drive-unit the SUB110 can faithfully reproduce the lower frequencies down to 39 Hz and up to a peak SPL of 132.5 dB.

It's an ideal partner for all Outline compact point-source system such as Vegas 24, Vegas 6.5, Vegas 8 CX, DVS Series.

INSTALLATION POINTS

The loudspeaker has an M20 threaded point to be used with a loudspeaker stand. It is always recommended to respect the stated limits when using any accessory.

The lightweight cabinet offers a few rigging possibilities:

12 female M6 threaded flying points are available for multiple purpose. Please notice that is not possible to hang up the unit directly from the threaded points but the system needs an appropriate accessory as shown in the following picture.

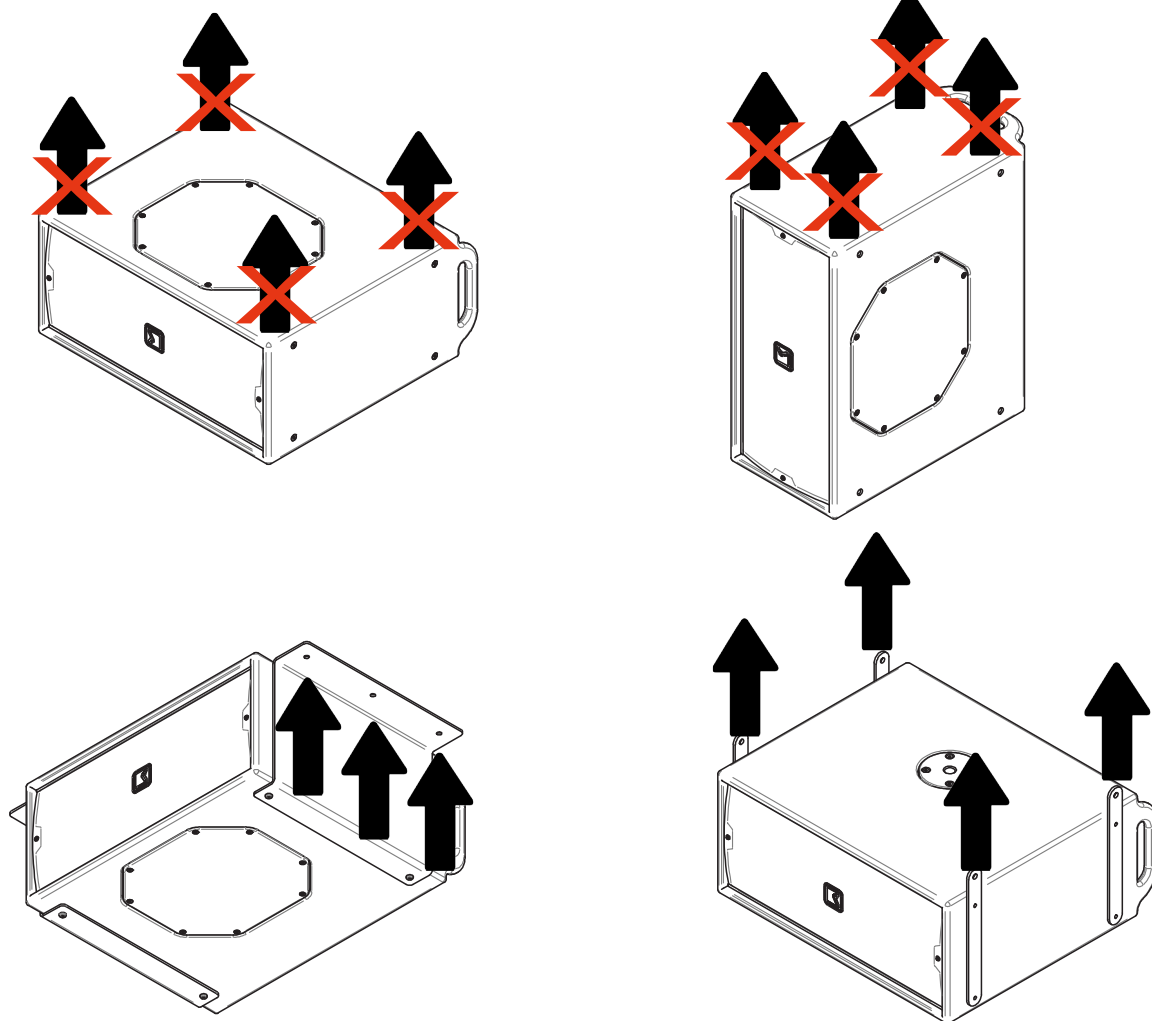

OVERALL DIMENSIONS

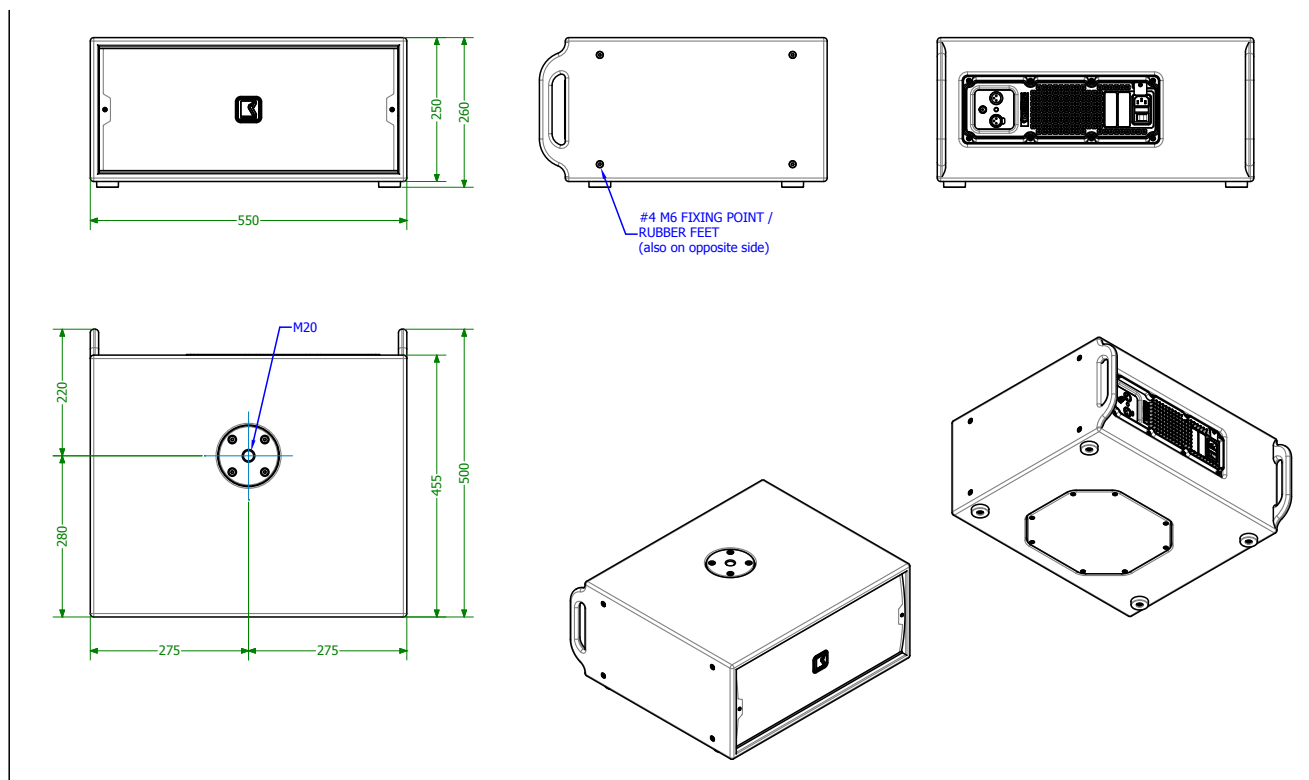

TECHNICAL SPECIFICATIONS

PERFORMANCE SPECIFICATIONS

Frequency Response (-10 dB)	39 Hz – 100 Hz (preset 1: standard)
Nominal Dispersion	Quasi-Omnidirectional
Power amplifier	Type: Class D (digital) / Input impedance: 4.5 k Ω balanced Rated power: 700 W EIAJ at 8 Ω / Cooling: passive radiator Special feature: four on-board presets, selectable input gain
Maximum SPL Output *	132.5 dB SPL (preset 1: standard)

* calculated using +10 dB Crest Factor signal @ 1 m, Half space

PHYSICAL

Component	1 x 10"
Connectors	Signal: 1 XLR + 1 Link Out Mains: IEC C14 Socket
Cabinet Material	Baltic birch plywood
Cabinet Finish	Black polyurea coating
Grill	Epoxy powder coated steel
Installation Points	12 x M6 threaded points
Pole Mount	1 x M20 threaded point
Height	260 mm – 10 1/8"
Width	550 mm – 21 5/8"
Depth	500 mm – 19 5/8"
Weight	22 kg – 48.5 lb

AMPLIFIER CONNECTION

The amplifiers are directly integrated into the Sub110 SP enclosures. The amplifier module is completely autonomous and designed to be immediately ready for use (plug & play) once connected to the power.

The integrated DSP allows the management of

the input audio signal. In fact, since the enclosure doesn't have any passive crossover, the filters are all managed by the DSP. It is possible to choose between four different presets.

Below you will find the elements offered by the management panel:

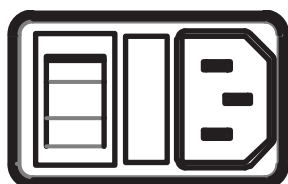

Input power: main power supply socket with power button and fuse holder (F 3.15 A, L 250 V).



Analog signal input: XLR connector for balanced analog signal.

Analog signal link: XLR connector in parallel to the input connector.

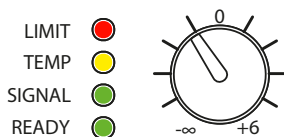

Potentiometer and metering: the system gain can be regulated with the dedicated potentiometer which can be set from $-\infty$ to $+6$ dB.

READY: system is powered and ready to be used;

SIGNAL: input signal presence;

TEMP: temperature warning (blinking), gain reduction (fast blinking), output shutdown (steady on);

LIMIT: output channel limiting.

- PRESET 4
- PRESET 3
- PRESET 2
- PRESET 1



Preset selection: button for the selection of one of the four available presets. It is possible to see the active preset with the help of the dedicated LEDs.

PRESET

Outline has made available four presets that are potentially useful in any situation.

On the rear panel of SUB110 there is a button for the selection of one of the four available presets. It is possible to see the active preset with the help of the dedicated LEDs.

In particular there are four presets named in accordance on the application they were designed for:

- Standard, for plug & play applications;
- Punch, with a boost on low frequencies;
- Music, for live and disco applications;
- LP120, with the low pass filter at 120 Hz.

APPENDIX - PERIODIC CONTROLS

All the loudspeakers, before the shipment, are fully tested at the end of the production line, but before the system is installed an overall check shall be performed to ensure that the system has not been

damaged during the shipment. Periodic controls shall be performed at regular time intervals. The following table represents an ideal check list.

Loudspeaker Serial Number:				Position:				
Date								
Transducers Impedance								
Amplifier								
Loudspeaker cabinet								
Loudspeaker grills								
Screws								
Additional notes								
Signature								



Outline carries out on-going research for product improvement. New materials, manufacturing methods and design upgrades are introduced to existing products without prior notice as a routine result of this philosophy. For this reason, any current Outline product may differ in some aspect from its description, but will always equal or exceed the original design specifications unless otherwise stated.

© Outline 2020
Operating manual product code: Z OMSUB110SP
Release:200203
Printed in Italy