

# **outline**

**INSTRUCTIONS MANUAL**

**GENIUS SERIES  
CONTROLLERS**

**PROFESSIONAL AUDIO**

User Guide

Outline Genius series (DSP)

Version 1.4

May 11<sup>th</sup>, 2005

## Quick Reference Guide

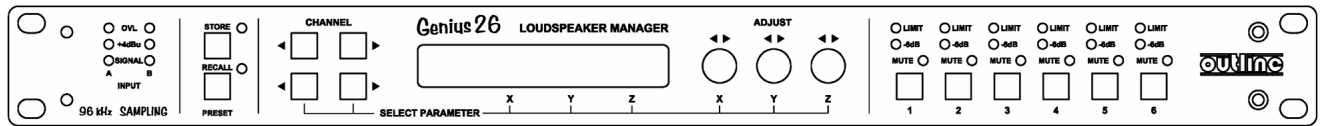

### Display

The LCD displays preset and parameter information. The default screen is shown after start up and displays the number and name of the current preset on the lower line of text. When navigating around the adjustable parameters, other information is shown.

### Channel Select Buttons

The currently selected input or output channel is shown in the top left corner of the display. Pressing the channel select buttons scrolls through the available inputs and outputs. If operating stereo linked the channel pair is shown. For example 'CH A+B' means both input A and B parameters.

### Edit Select Buttons

The name of the edit parameter page is displayed in the bottom left portion of the LCD. Pressing the edit select buttons moves through the available parameter pages for the current input or output.

### Parameter Knobs

Up to three parameters are shown on the display. The parameter name is shown with its' current value below. Where appropriate, parameters are grouped according to function. For example the parametric equalisation page shows centre frequency, width and gain. Turning a parameter knob clockwise will increase the value of a parameter, turning anti-clockwise will decrease it. Turning a knob rapidly will cause the action to 'accelerate', so the value changes more rapidly.

### Mute Buttons

The LEDs next to the mute buttons indicate their current status. Pressing a mute button toggles between the mute on and off.

### Store Button

The unit has 45 preset locations. To store a preset in a location, press the store button and use the parameter knobs to select the preset location and name the preset. Pressing the store button again completes the task. Pressing any button other than store during the process cancels the procedure.

### Recall Button

To recall a preset, press the recall button and use parameter knob X to select the required preset. Pressing the recall button again will activate the preset. You will then be asked to confirm by pressing recall once more. As with the store function, pressing any button other will cancel the process.

Quick Reference Guide .....	3
Display .....	3
Channel Select Buttons .....	3
Edit Select Buttons .....	3
Parameter Knobs .....	3
Mute Buttons .....	3
Store Button .....	3
Recall Button .....	3
Important Safety Information .....	5
Regulatory Compliance .....	5
Thanks and Unpacking .....	5
Introduction and Key Features .....	6
Introduction .....	6
The User Guide .....	6
Front Panel .....	6
Input Signal Indicators .....	7
Preset Store and Recall .....	7
Channel Select Buttons .....	7
Edit Select Buttons .....	7
Text display .....	7
Parameter knobs .....	7
Output signal and limiter indication .....	7
Mute buttons and status LEDs .....	7
Secure Button (on the rear) .....	8
Rear Panel .....	8
Power Inlet .....	8
Network expansion port .....	8
Audio Input connectors .....	8
Output connectors .....	8
Communications port connector .....	8
Operation .....	9
Starting up .....	9
Selecting a Factory Preset .....	9
Creating a Crossover .....	9
Navigation and Viewing Parameters .....	9
Navigation .....	10
<i>Preset Store and Recall</i> .....	10
<i>Preset Recall</i> .....	10
<i>Preset Store</i> .....	11
DSP Processing layout .....	12
Input DSP block diagram .....	12
Output DSP block diagram .....	12
Stereo / Mono Formats .....	12
DSP processing .....	13
Input Channels .....	13
Output Channels .....	15
Utilities .....	19
Factory Presets .....	20
EQ and Filter Response Graphs .....	21
Technical Specification .....	22
General .....	22
Processing .....	22
Connectors .....	22

## Important Safety Information

Please read carefully and keep the following instructions and safety information. Heed all warnings and follow all instructions.

- **Do not remove covers. There are no user serviceable parts inside, please refer servicing to qualified service personnel.**
- **This equipment must be earthed.**
- Protect the power cord from being walked on or pinched particularly at plugs, convenience receptacles, and the point where they exit from the apparatus.
- Only use attachments/accessories specified by the manufacturer.
- Servicing is required when the apparatus has been damaged in any way, such as the power supply cord or plug is damaged, liquid has been spilled or objects have fallen into the apparatus, the apparatus has been exposed to rain or moisture, does not operate normally, or has been dropped.

### Regulatory Compliance

This product complies with both the EMC Directive (89/336/EEC) and the Low Voltage Directive (73/23/EEC) as issued by the Commission of the European Community.

Compliance with these directives imply conformity with the following European standards:

- EN60065      Product safety
- EN55103-1    Electromagnetic Interference (Emission)
- EN55103-2    Electromagnetic Susceptibility (Immunity)

This product is intended for operation in the E2 (commercial & light industrial) and E3 (urban outdoors) Electromagnetic Environments.

## Thanks and Unpacking

Thank you for choosing an OUTLINE Genius series digital loudspeaker management system for your application. Please spare a little time to study the contents of this manual, so that you obtain the best possible performance from this unit.

All OUTLINE products are carefully engineered for world-class performance and reliability. If you would like further information about this or any other OUTLINE product, please contact us to [info@outline.it](mailto:info@outline.it). We look forward to helping you in the near future.

### Unpacking the OUTLINE Genius series processor

After unpacking the unit please check carefully for damage. If damage is found, please notify the carrier concerned at once. You, the consignee, must instigate any claim. Please retain all packaging in case of future re-shipment.

## Introduction and Key Features

### Introduction

The OUTLINE Genius series of loudspeaker management systems represent the current state-of-the-art. Taking advantages of the latest advances in analogue to digital conversion and digital signal processing technologies the units achieve performance levels that have only recently been made possible.

This modern design is combined with OUTLINE Factory Presets to deliver the optimal match for OUTLINE cabinets and systems. These presets allow the user to simply achieve the best possible performance from any OUTLINE loudspeaker.

### Key Features

- Outline minimal signal path design
- Sonically superb ADC / DAC combination; a carefully matched pairing of the best devices from Burr Brown and Wolfson
- Newly released family of Analogue Devices SHARC DSP
- Extended bandwidth; 96kHz sampling frequency provides for a nominally flat response to 40kHz.
- Parameter knob and LCD provide a rapid, user-friendly control interface

These key features should be focused on the OUTLINE unit – these are examples / ideas really.

## The User Guide

This user manual gives a progressively more detailed description of the functions of the OUTLINE Genius series loudspeaker management systems. A single page quick reference guide is provided for those users who are experienced with this type of equipment and just need to know how to 'drive' the front panel.

A detailed explanation of the front and rear panel controls and indicators is contained in the next section. The final section describes each individual function or feature with annotated images explaining its' use. Where appropriate, the LCD is shown to further elaborate on the units' operation.

To complete the manual a reference section is included, describing the technical performance of the device complete with graphs of filter responses and details of the *Factory Presets* and their configuration.

## Front Panel

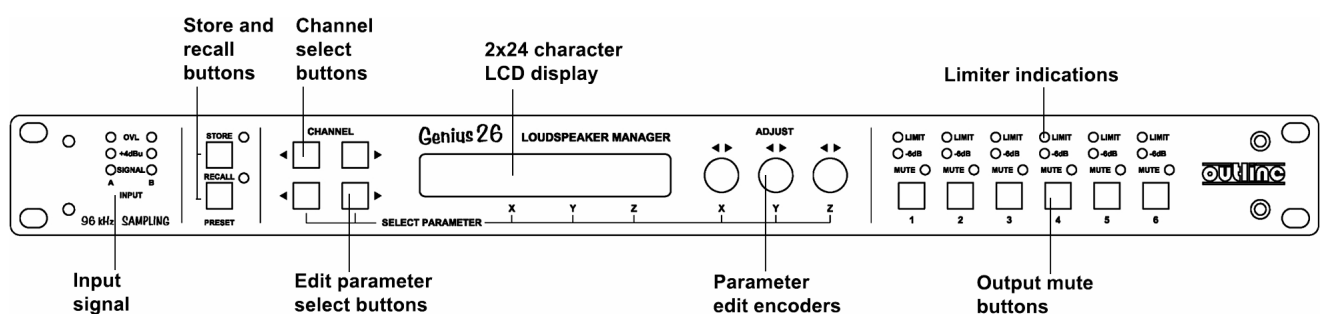

## Input Signal Indicators

A set of three pairs of LEDs indicate signal present, +4dBu and input clip for each channel. The signal present LEDs operate at approximately -40 dBu, giving a useful indication of even relatively low input signal levels. The +4 dBu LEDs are intended to show nominal operating level and can also be useful for setting system gain structure. Clip LEDs warn the user of input overload and operate at +19 dBu.

## Preset Store and Recall

These controls provide access to the 45 presets stored within the device. Pressing the store button allows the user to name a preset and choose which memory location it will be held in. Pressing store button again completes the process. The Recall function operates in a similar way, pressing the recall button allows the user to select which preset they require, pressing the button for a second time, then confirming, recalls the new DSP settings.

*Note that presets cannot be stored or recalled when Secure mode is activated.*

## Channel Select Buttons

The currently selected channel is displayed on the top left hand corner of the LCD. Pressing the channel buttons scrolls through the available input and output channels and finally through the utility functions and back to the default screen. If operating a stereo linked preset, the channel name will indicate the channel pairing. For example 'A+B' means both input A and B parameters. The name of the output will be shown briefly at the top of the display when stepping onto an output.

## Edit Select Buttons

The currently selected edit parameter page is displayed on the bottom left corner of the LCD. Pressing the edit select buttons moves through the available parameters for the current input or output.

## Text Display

Preset, channel, parameter and status information is shown on the 2x 24-character text display. In most screens the currently selected channel is displayed on the upper line and the edit parameter on the lower line. To simplify the display and enhance security, some parameters or parameter pages are omitted when not relevant.

## Parameter Knobs

Three velocity sensitive parameter knobs are used to adjust parameters shown on the display. Up to three parameters at a time are displayed on the screen. The parameter name is shown above the parameter value in each of the three screen sections. The parameter knobs have a fixed association with the screen sections; the rightmost parameter knob adjusts the rightmost parameter and so on.

## Output Signal / Limiter Indication

Two LEDs are provided for each output channel. These show the signal level relative to the limiter threshold. The yellow LED will light when the signal is 6dB below the threshold and the red warning LED will light when the limiter threshold is reached.

## Mute Buttons and Status LEDs

Each output has a mute button and associated mute status LED. Pressing the button toggles the mute on and off. *Note that the mute buttons do not function when the Secure mode is activated.*

## Secure Button (on the rear)

A momentary button is fitted behind the rear panel, between the output XLRs and the RS232 port. When activated, this will disable all the front panel controls so they cannot affect the signal path, making the unit secure against tampering. When in secure mode, the indicators still operate normally. Note that the communications port is still active in secure mode.

## Rear Panel

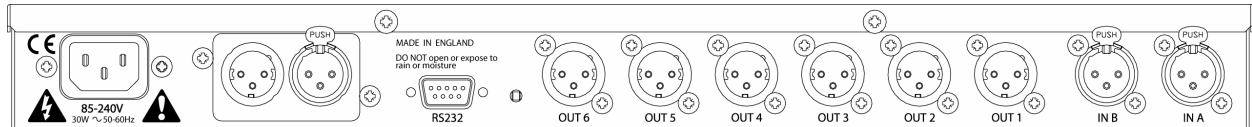

## Power Inlet

The OUTLINE Genius series unit should be connected to a suitable mains electricity supply using the cable supplied. The processor has a switch mode power supply that is capable of operating with a nominal mains voltage of 85V to 240V, 50/60Hz without re-configuration.

## Network Expansion Port

Where a future network card can be fitted.

## Audio Input Connectors

All audio connections are fully balanced and wired pin-1 ground, pin-2 hot & pin-3 cold. The two inputs have pin-1 connected directly to the chassis and feed the signal processing chains. If an unbalanced source is used, a connection should be made between the pin-3 'cold' signal and the ground connection of the unbalanced source.

## Audio Output Connectors

The processed outputs are impedance balanced, and wired pin-1 ground, pin-2 hot and pin-3 cold. An unbalanced input may be driven by connecting pin-3 'cold' signal to the ground connection of the unbalanced destination input. Note that output pin-1's are ground lifted at audio frequencies but connected to ground at RF for good EMC performance. The intention being that the amplifiers the processor is driving should be responsible for the grounding of their input cable shields.

## Communications Port Connector

A Genius series processor may be controlled entirely from another controller, typically a Personal Computer, running an application that is compliant with the ObCom standard. Connection will normally be made to the controller via this serial port connector. This port is also used for updating the firmware in the unit.

*Note that the communications port is NOT disabled when the front panel is made secure using the secure button.*



## Operation

### Starting up

The unit will energise as soon as power is applied to the IEC inlet; there is no power switch. During the start up process the firmware application model number and version numbers are displayed and the outputs are muted until the unit has completed its internal checks. Once the start-up routines are complete and the unit is ready to pass audio. The DSP signal path will be restored to the current settings when it was last powered down and the audio signal is gradually ramped up to its correct level.

### Selecting a Factory Preset

The Genius series processors have a library of *Factory Presets* designed to suit a range of OUTLINE enclosures.

*Factory Presets* contain some parameters that are fixed and hidden from view; the remainder of the DSP parameters are available for user manipulation. The number and type of hidden parameters is dependant on the Factory Preset, typically crossover frequencies, output delay and some EQ's are hidden; those settings that are a function of the loudspeaker cabinet design and should not require adjustment for different applications.

To recall a *Factory Preset* for a particular cabinet or system, press Recall and use the left hand parameter knob X to scroll through the available factory preset locations (as indicated by a box symbol after the preset number). Once the appropriate preset has been selected press recall again, at which point you will be asked to confirm the action by pressing recall for a third time. This is to guard against accidental recall of Presets.

*Factory Presets* are locked so they cannot be over-written. The user can, however, store an edited version of a Factory Preset in any free preset location.

Details of all the *Factory Presets* including output designations can be found in Appendix A.

### Creating a Crossover

In addition to the *Factory Presets* the unit has two further '*Base Presets*'; mono and stereo. These *Base Presets* are stored in locations 1 and 2 respectively, they can be used to develop settings for any loudspeaker combination and are recalled in the same way as the *Factory Presets* described above. These Presets are also locked but the user can name and store their own edited versions in any free preset location.

### Navigation and Viewing Parameters

Many of the processing elements in each input and output path have features that may be controlled by the user, such as gain, frequency or limiter threshold. We call these adjustable features parameters.

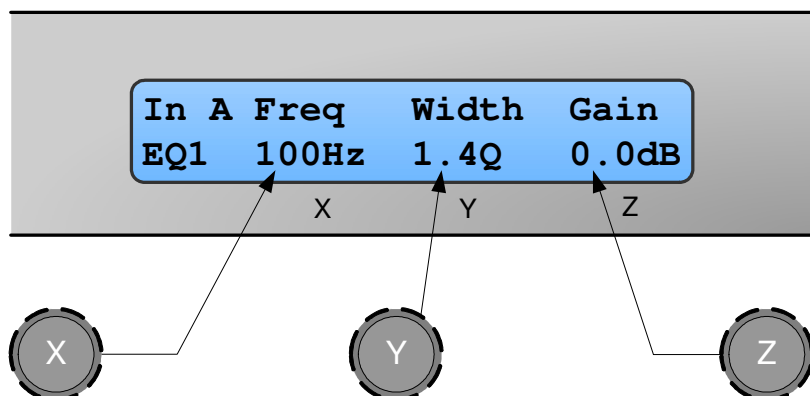

A parameter may be adjusted when it is displayed by turning one of the three-parameter knobs. Each of the three-parameter knobs is associated with a zone on the display. Adjusting the leftmost parameter knob will change the value of the parameter showing in the leftmost zone of the display and so on. Turn a knob clockwise to increase the value of a parameter, or anti-clockwise to decrease it. The knobs are velocity-sensitive so turning a knob rapidly will cause the action to 'accelerate', so the value changes more rapidly.

## Navigation

The DSP parameters are organised by channel. The currently selected channel is shown in the top left hand corner of the display. You can navigate between the channels by pressing the channel buttons. Pressing the channel buttons will scroll through the channels, utilities and back to the default screen. When using a Preset that is stereo linked, the channel selection will reflect this. For example '1&4' indicates outputs 1 and 4. When navigating onto an output channel, the usage of the output, as define in the factory preset, will be shown briefly at the top of the screen.

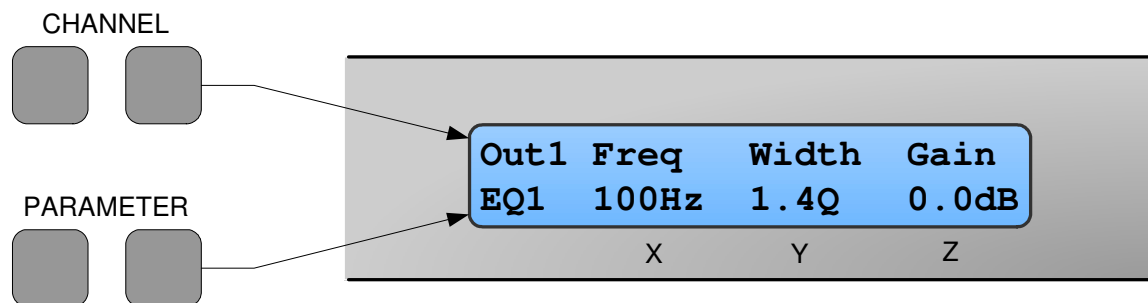

Pressing the edit navigation buttons gives access to the various pages of parameters available for each channel. The currently selected page is shown in the bottom left hand corner of the display, this is omitted on some pages where the function is obvious. The screen shows up to three (normally related) parameters for a given part of the processing functions on a given channel.

The edit buttons allow you to scroll, in either direction, through the different processing pages for a given Channel. When you go past the last page, you will be returned to the default page.

The channel buttons allow you to scroll, in either direction, through the input and output channels, whilst trying to maintain the currently viewed processing block. If the channel you scroll to does not have the currently viewed processing block, the next one will be shown instead.

*NB. When the unit powers-up, the settings will be the same as those when the unit was last switched off.*

## Presets

The device contains a total of forty-five user and *Factory Presets*. The user cannot overwrite the basic mono, basic stereo or *Factory Preset* programs.

## Preset Recall

To select an existing Preset, press the Recall Button so the indicator above it illuminates. Turn parameter knob X until the required Preset number is shown on the display. Factory presets are indicated by a box symbol appearing after the preset number. Press the Recall Button again to activate the Preset. Pressing any other button will cancel the operation.

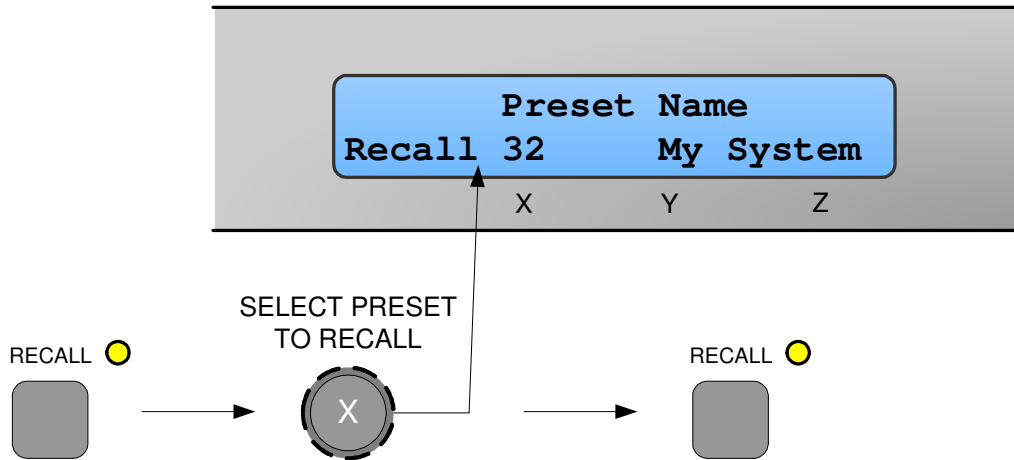

Users can develop their own Preset based on one of the basic or *Factory Presets* stored within the device. Once a basic or user Preset has been recalled, a user has complete freedom to adjust any or all of the parameters. *Factory Presets* can be used as the basis for user Presets but they have some parameters that are predefined as a function of the loudspeaker system. These parameters are 'hidden' from the user, as they should be constant regardless of application.

## Preset Store

To store the current Preset in a user location, press the Preset Store Button so the indicator above it illuminates. Turn the first parameter knob until the required Preset location number is show on the display. A Preset name of up to 12 characters in length can be entered using parameter knobs Y and Z. Pressing the Store Button again completes the process and stores the Preset. As with Preset Recall, pressing any other button cancels the operation.

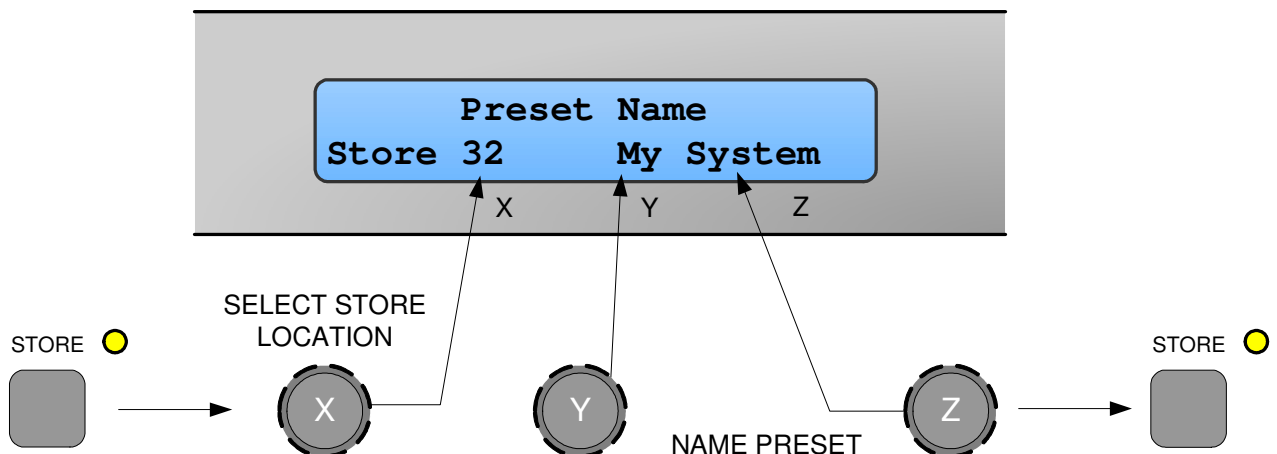

The user can overwrite non-protected Presets only; if an attempt is made to save a Preset in a location already occupied by a basic or *Factory Preset* a 'LOCKED PRESET' message is displayed.

## DSP Processing layout

### Input DSP block diagram

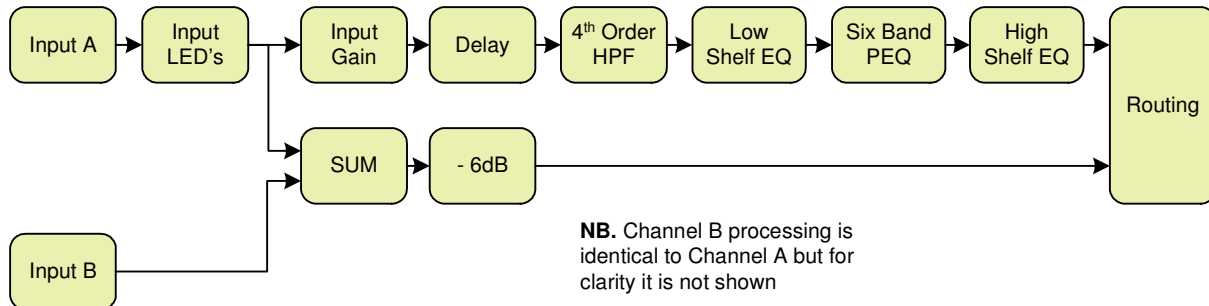

### Output DSP block diagram

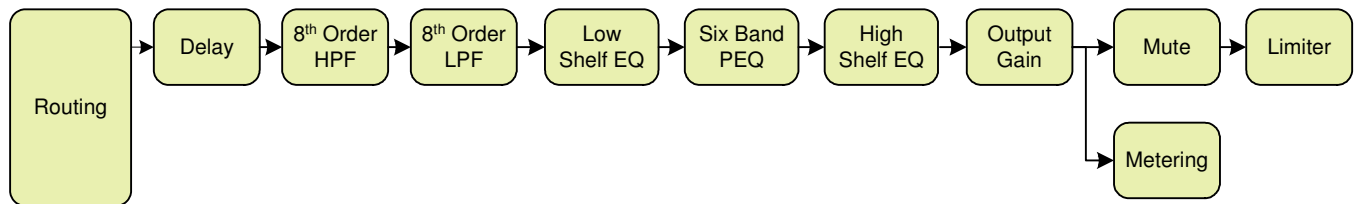

## Stereo / Mono Formats

There is only one 'standard' layout of the processing blocks, but flexible routing and control linking allows this layout to be adapted to a wide variety of applications.

There are two 'Formats', Mono or Stereo. With the Mono format, all outputs have unique parameter settings, and all outputs are identical in terms of processing functions and routing capability. This is the most flexible Format.

Stereo format pairs the inputs and outputs for stereo operation, the parameters of each member of the pair being identical. The routing of inputs to outputs is fixed. This format is intended for symmetrical stereo operation, eliminating the need to make identical parameter adjustments for each channel.

The channel pairing is:

- Left and Right Inputs
- Outputs 1 (routed from L input) and 3 (routed from R input) [1 and 4 for Genius 26]
- Outputs 2 (routed from L input) and 4 (routed from R input) [2 and 5 for Genius 26]
- Outputs 3 (routed from L input) and 6 (routed from R input) – [Genius 26 only]

## DSP processing

### Input Channels

#### Gain

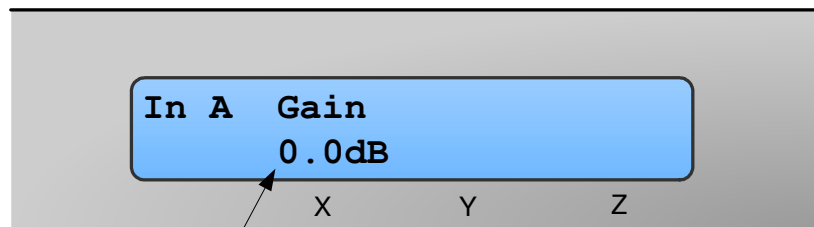

- Knob X: Gain, adjustable in 0.2dB steps from -80 dB to +20dB

#### Delay

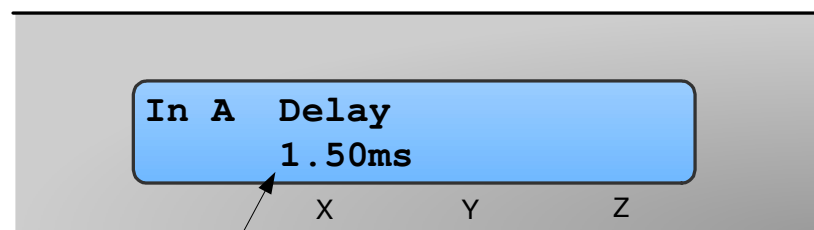

- Knob X: Delay, adjustable in variable steps from 0 to 400ms

The delay parameter is adjustable in fine steps at low values; the adjustment becomes progressively coarser as the value increases. The velocity sensitive Parameter Knobs therefore provide accurate setting of driver offset delays (typically below 10ms) and rapid setting of longer system alignment delays.

## High Pass Filter

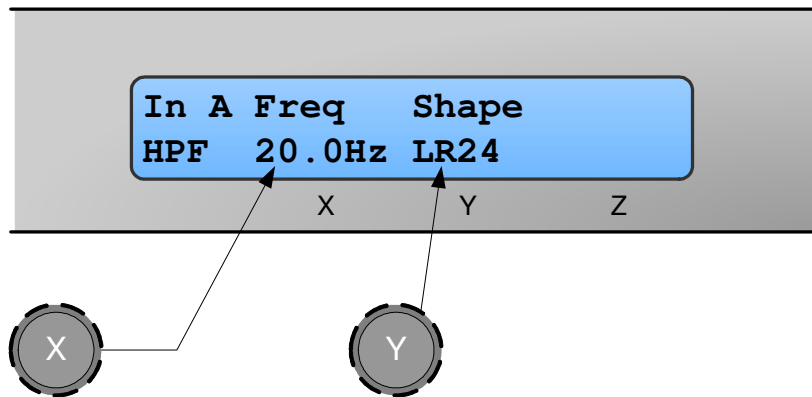

- Knob X: Frequency, out (off), 10.0Hz to 25.6kHz in variable steps
- Knob Y: high pass filter type

System high pass filtering is provided for the input signal. This is the preferred location for high pass filtering as it affects all outputs and can therefore improve inter-band phase relationships. Filter type is selectable from Butterworth, Bessel, Linkwitz-Riley and Hardman. Filter slopes of up to 4th order or 24dB / octave are provided. Not all filter types are available in all slopes. For example 18dB / octave Linkwitz-Riley filters do not exist.

The Hardman type filter is always described by its' order as the filter becomes progressively steeper rather than following a linear slope so a dB/octave description is not accurate.

## Parametric Equalisation

Eight sections of equalisation are provided, two shelving filters and six fully variable parametric sections.

### High and Low shelving filters

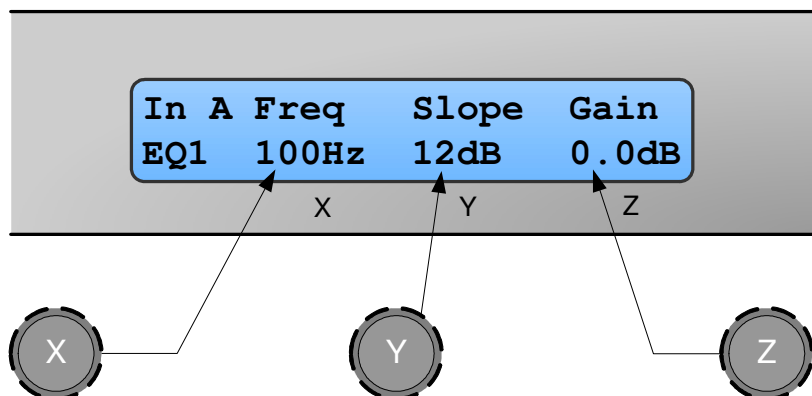

- Knob X: Frequency, 10.0Hz to 25.6kHz in variable steps
- Knob Y: Slope, 6 to 12dB / octave in 1dB steps
- Knob Z: Gain, +/-15dB in 0.2dB steps

The frequency is specified as point where the filter deviates by 3dB from the gain value.

## Parametric filters

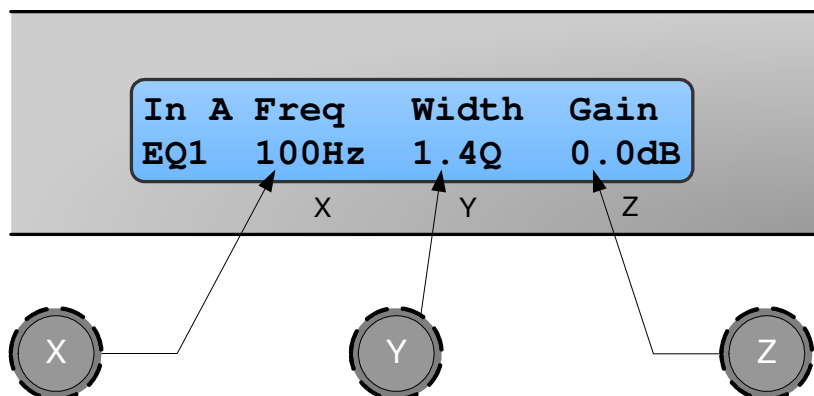

- Knob X, Centre Frequency, 10.0Hz to 25.6kHz in variable steps
- Knob Y, Width, display selectable, Q or BW (Bandwidth)
  - BW adjustable from 0.05 to 5 octaves in variable steps
  - Q adjustable from 14.2 to 0.2 in variable steps
- Knob Z, Gain, +/-15dB in 0.2dB steps

## Output Channels

### Gain and Polarity

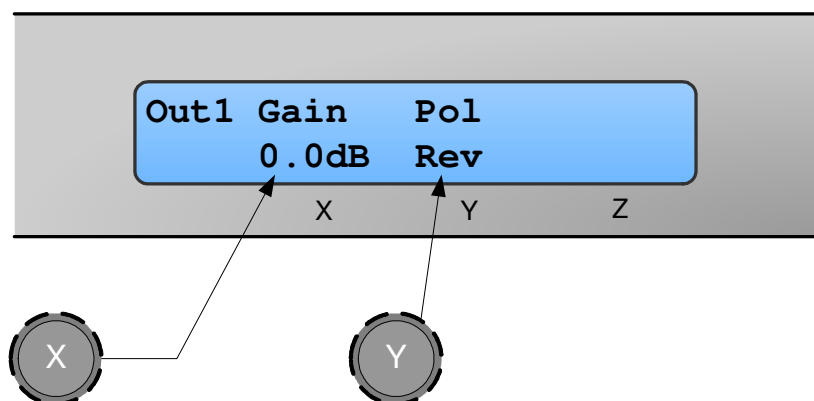

- Knob X: Gain, adjustable in 0.2dB steps from -80 dB to +20dB
- Knob Y: Polarity, selectable, normal or reversed with reference to other outputs

## Delay

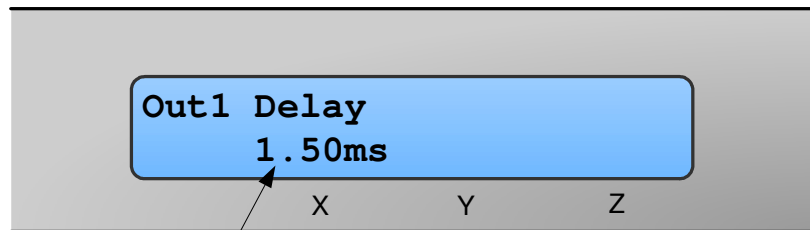

- Knob X: Adjustable in variable steps from 0 to 80ms

As for input delay, velocity sensitive Parameter Knobs provide finer adjustment at low levels and rapid selection of higher values.

## High and Low Pass Filters

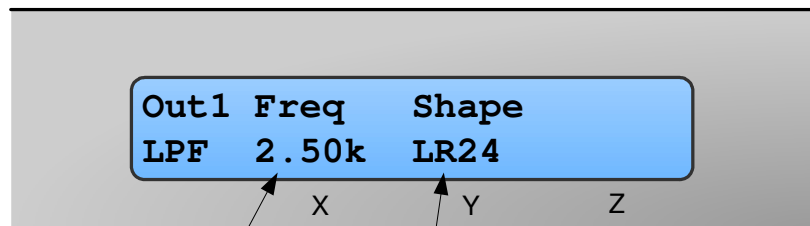

- Knob X: Frequency, <<out, 10.0Hz to 25.6kHz, out>>
- Knob Y: high pass filter type

Filter type is selectable from Butterworth, Bessel, Linkwitz-Riley and Hardman. Filter slopes of up to 8th order or 48dB / octave are provided. Not all filter types are available in all slopes. For example 18dB / octave Linkwitz-Riley filters do not exist.

The Hardman type filter is always described by its' order as the filter becomes progressively steeper rather than following a linear slope so a dB/octave description is not accurate.



## Parametric Equalisation

Eight sections of equalisation are provided in a similar format to the input channel equalisation; two shelving filters and six parametric.

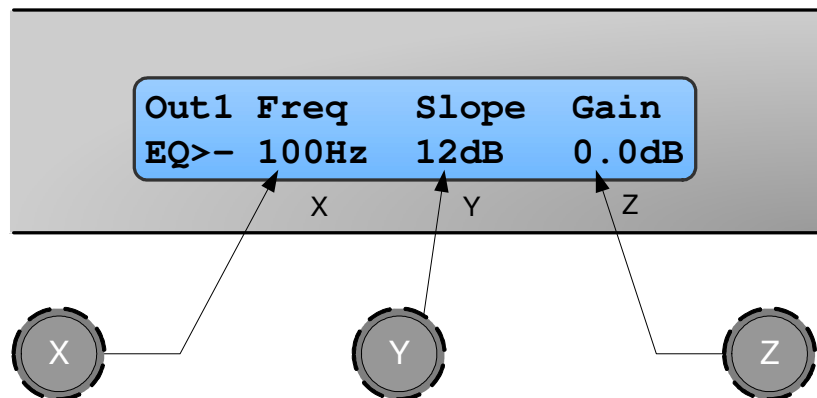

- Knob X: Frequency, 10.0Hz to 25.6kHz in variable steps
- Knob Y: Slope, 6 to 12dB / octave in 1dB steps
- Knob Z: Gain, +/-15dB in 0.2dB steps

The frequency is specified as point where the filter deviates by 3dB from the gain value.

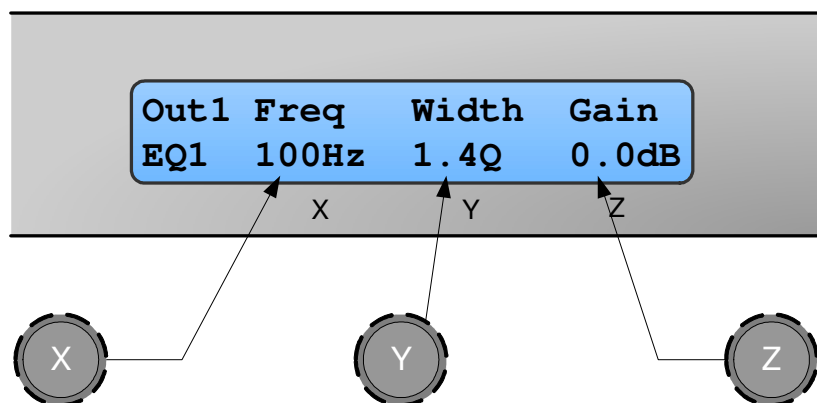

- Knob X, Centre Frequency, 10.0Hz to 25.6kHz in variable steps
- Knob Y, Width, display selectable, Q or BW (Bandwidth)
  - BW adjustable from 0.05 to 5 octaves in variable steps
  - Q adjustable from 14.2 to 0.2 in variable steps
- Knob Z, Gain, +/-15dB in 0.2dB steps

## Limiters

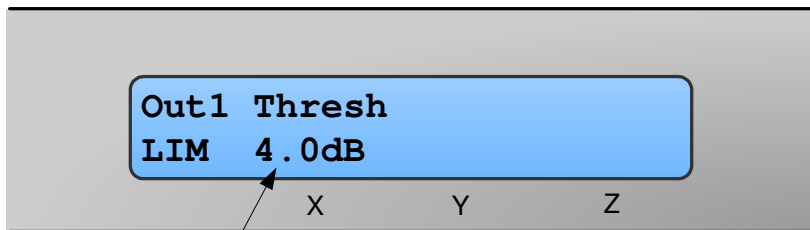

- Knob X: Threshold, -40dBu to 20dBu in 0.2dB steps

A high performance, low distortion limiter is provided on each output. Threshold is user adjustable; all other parameters are carefully calculated dependant on configuration to provide clean and effective control of signal dynamics.

## Routing

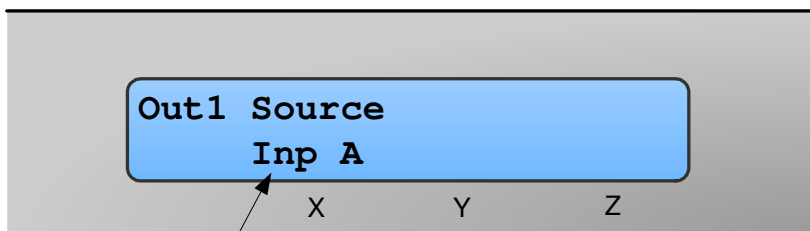

- Knob X: Output source, selectable; Input A, Input B or Sum A+B

Configures the routing from input to output. This function is only available in mono format Presets.

## Utilities

### Utility functions

Three utility functions are provided to adjust screen contrast, the display units used for parametric equalisation bandwidth and switch between stereo and mono mode.

The device automatically adjusts for the variations in display contrast as the temperature of the LCD changes. The screen contrast utility control sets the base contrast of the screen and also allows optimization for a given viewing angle.

Parametric equalisation width parameters can be displayed in either 'Q' or bandwidth, expressed in octaves.

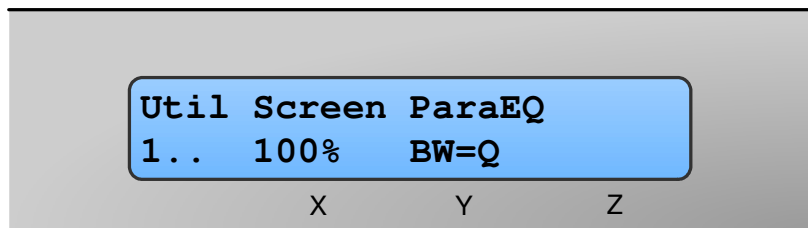

Care should be taken when swapping between mono and stereo mode as the parameter set for the left hand channels will be copied to the right hand side, overwriting those settings. This is not reversible and could represent quite a significant and potentially damaging change to the processing.

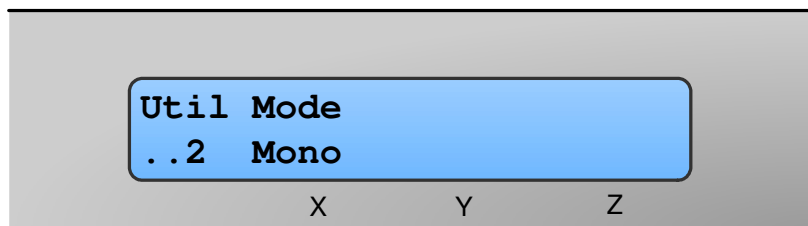

## Factory Presets

location	preset name	out1	out2	out3	out4	out5	out6
----------	-------------	------	------	------	------	------	------

Basic default programs

1	<b>basic stereo</b>	< 250	250 ~ 5K	5K >	< 250	250 ~ 5K	5K >
2	<b>basic mono</b>	full range	full range	full range	full range	full range	full range









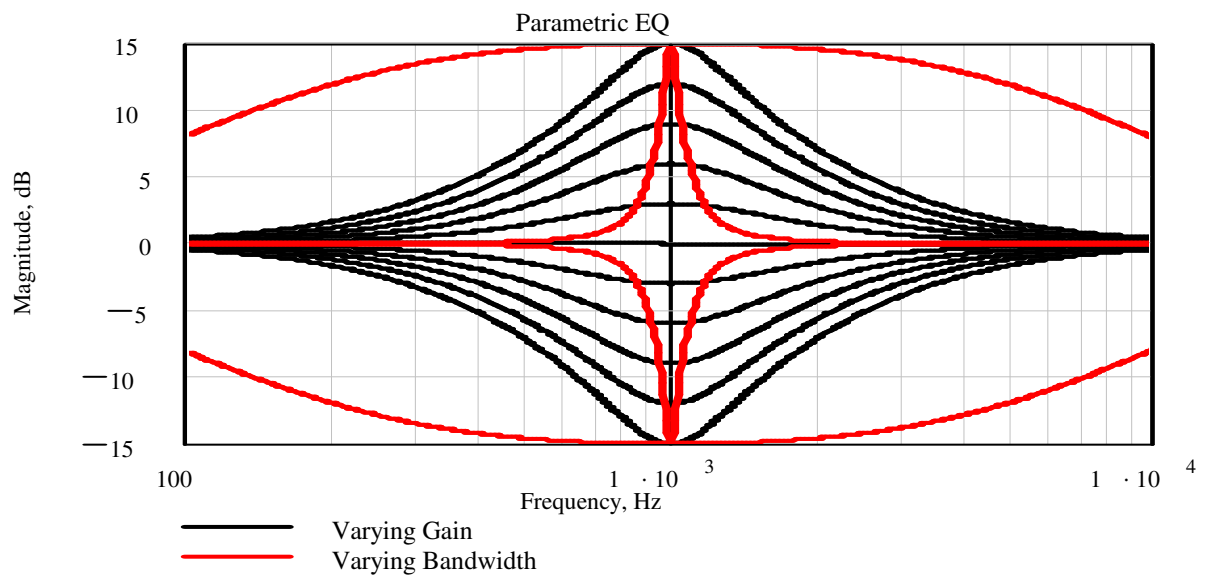
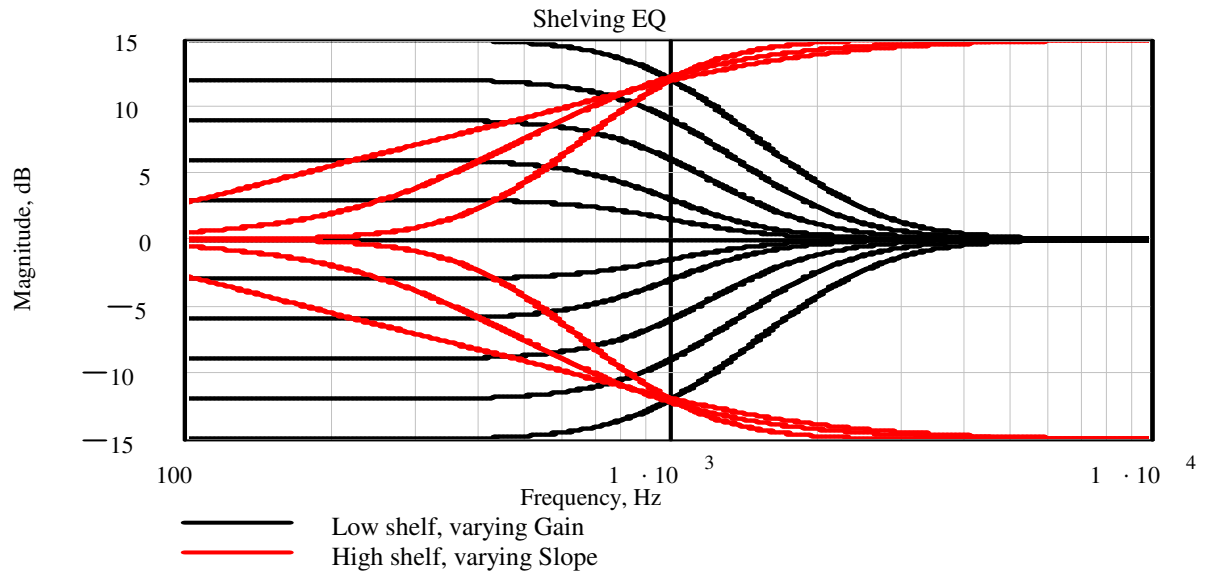

## EQ and Filter Response Graphs

Graphs need reformatting and crossover filter response graph(s) to be added



## Technical Specifications

### General

Inputs.....	two (Genius 24 & 26)
Input Impedance.....	> 10k Ohm Electronically balanced
Maximum Input level.....	+20dBu
Outputs.....	four [Genius 24] or six [Genius 26]
Output Impedance.....	<100 Ohm, ground balanced
Maximum Output Level.....	+20 dBu into 600ohm load
Sample Rate.....	96kHz
Frequency Response.....	10Hz to 40kHz, +/- 1.0dB (filters disabled) 10Hz to 20kHz, +/- 0.25dB (filters disabled)
THD.....	<0.01%, (+10dBu, 20Hz to 20kHz, 30kHz bandwidth)
Dynamic Range.....	>111dB (A weighted, 22kHz bandwidth) >108dB (un-weighted, 22kHz bandwidth)
Serial Comms Data.....	38.4kbaud, format: 8 data, 1 stop, no parity

### Processing

Gain.....	+20dB to -80dB and mute, 0.2dB steps
Output Ch. Source.....	Input A, Input B and SUM
HP filter frequency.....	Off, 10Hz to 25.4kHz, 1/36 octave steps
LP filter frequency.....	10Hz to 25.4kHz and off, 1/36 octave steps
LP / HP filter type.....	12, 18 & 24dB / octave Bessel and Butterworth, 12, 24 and 48dB / octave Linkwitz Riley and 4 <sup>th</sup> or 8 <sup>th</sup> order Hardman
Delay.....	Input 400ms, output 80ms
Limiter.....	High performance limiter, adjustable threshold in 0.2dB steps, automatic time constants
EQ frequency.....	10Hz to 25kHz, 1/36 octave steps
EQ gain.....	+15dB to -15dB, 0.2dB steps
EQ width.....	5.0 to 0.1 octaves bandwidth, 1/36 octave steps

### Connectors

Audio inputs.....	3 pin female XLR
Audio outputs.....	3 pin male XLR
Serial comms.....	9 pin female 'D type'
Network comms.....	Future option
Mains.....	3 pin IEC
Mains Power.....	Universal switch-mode PSU, 85v to 250v AC, 50/60Hz
Consumption.....	< 25watts
Dimensions.....	Height 1.75", 44mm Width 19", 482mm Depth 10", 254mm
Weight.....	2.7 Kgs net

For further info and DSP presets mail to [info@outline.it](mailto:info@outline.it) or call us to ++39 030-35.81.341