

# EIDOS 265LA

RECOMMENDED SYSTEM DESIGNS

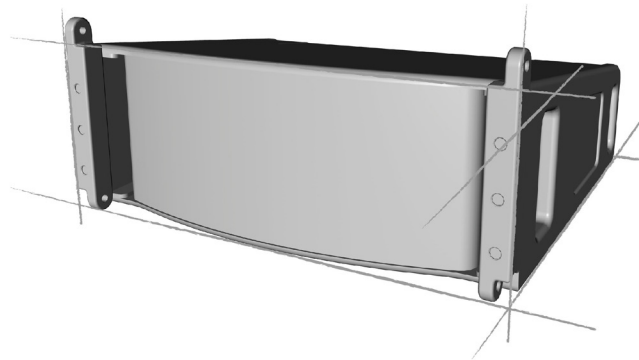

October 2019 VER 2.1

**ROUTINE**

# SYSTEMS' DESCRIPTION

PRODUCT DESCRIPTION: EIDOS 265 LA is a passive loudspeaker line array element. It features two 6.5" mid-woofers (1.75" voice coil and ferrite magnet) and a 1.4" throat-exit compression driver (2.5" voice coil) on a dedicated waveguide. Between the two bandwidths, filtering is carried out by an internal passive cross-over, utilizing top-grade components. Up to 4 cabinets can be powered from a single channel of amplification. Each EIDOS 265 LA has a nominal impedance of 8  $\Omega$  and can handle up to 500 W AES and 2000 W peak. Connection is in the form of two NL4 wired in parallel.

KITS DESCRIPTION: These configurations ensure the best ratio between loudspeakers & amplifiers quantity, thus becoming an excellent investment with a fast economic return. Their strong plug&play vocation has been ensured by providing all the necessary accessories to provide complete solutions.

## EIDOS 265 LA SILVER CONFIGURATION

Minimum configuration suitable to reinforce a 100 to 250 people audience area, with high size/power ratio.

## EIDOS 265 LA GOLDEN CONFIGURATION

Complete solution suitable to reinforce a 250 to 500 people audience area.

## EIDOS 265 LA PLATINUM CONFIGURATION

Complete solution to reinforce a 500 to 700 people audience area.

	EIDOS265LA	FLYSUB 15	SUB118	VEGAS24	T602
SILVER	8	2	-	-	2
GOLDEN	12	2	4	-	4
PLATINUM	16	4	8	4	6

---

## EIDOS 265 LA SILVER CONFIGURATION

---

EIDOS 265 LA	Small format line array element	8
FLYSUB 15	Riggable subwoofer, 1 x 15"	2
FRM-MCMPSS-L	EIDOS 265 LA main frame	2
V 982	EIDOS 265 LA connection bar for FRM-MCMPSS-L	2
FOOT 01	Pair of adjustable feet for ground stacking (2 pcs kit)	2
SPK 4X4-15	15 m loudspeaker cable (4 poles x 4 mm) with Neutrik speakon connectors	4
SPK 4X2.5-0.7	70 cm loudspeaker cable (4 poles x 2.5 mm) with Neutrik speakon connectors	6
FCE265LA-4P	Flight case suitable for four Eidos 265 LA enclosures	2
SCAP-FLYSUB 15	Weather protection cover for FLYSUB 15	2
TROLLEY 14	Wheeled trolley for FLYSUB 15	2
T602	2 CH Powersoft T series amplifier with DSP	2

\* See the bottom of the document for more details

---

## EIDOS 265 LA GOLDEN CONFIGURATION

---

EIDOS 265 LA	Small format line array element	12
FLYSUB 15	Riggable subwoofer, 1 x 15"	2
SUB 118	Subwoofer element, 1 X 18"	4
FRM-MCMPSS-L	EIDOS 265 LA main frame	2
V 982	EIDOS 265 LA connection bar for FRM-MCMPSS-L	2
FOOT 01	Pair of adjustable feet for ground stacking (2 pcs kit)	2
SPK 4X4-10	10 m loudspeaker cable (4 poles x 4 mm) with Neutrik speakon connectors	2
SPK 4X4-15	15 m loudspeaker cable (4 poles x 4 mm) with Neutrik speakon connectors	6
SPK 4X2.5-0.7	70 cm loudspeaker cable (4 poles x 2.5 mm) with Neutrik speakon connectors	10
FCE265LA-4P	Flight case suitable for four Eidos 265 LA enclosures	3
SCAP-FLYSUB 15	Weather protection cover for FLYSUB 15	2
TROLLEY 14	Wheeled trolley for FLYSUB 15	2
WHEELED BOARD 01	Wheeled trolley for SUB 118	4
T602	2 CH Powersoft T series amplifier with DSP	4

\* See the bottom of the document for more details

## EIDOS 265 LA PLATINUM CONFIGURATION

EIDOS 265 LA	Small format line array element	16
FLYSUB 15	Riggable subwoofer, 1 x 15"	4
SUB 118	Subwoofer element, 1 X 18"	8
FRM-MCMPSS-L	EIDOS 265 LA main frame	2
V 982	EIDOS 265 LA connection bar for FRM-MCMPSS-L	2
FOOT 01	Pair of adjustable feet for ground stacking (2 pcs kit)	2
SPK 4X4-10	10 m loudspeaker cable (4 poles x 4 mm) with Neutrik speakon connectors	8
SPK 4X4-15	15 m loudspeaker cable (4 poles x 4 mm) with Neutrik speakon connectors	6
SPK 4X2.5-0.7	70 cm loudspeaker cable (4 poles x 2.5 mm) with Neutrik speakon connectors	18
FCE265LA-4P	Flight case suitable for four Eidos 265 LA enclosures	4
SCAP-FLYSUB 15	Weather protection cover for FLYSUB 15	4
TROLLEY 14	Wheeled trolley for FLYSUB 15	4
WHEELED BOARD 01	Wheeled trolley for SUB 118	8
T602	2 CH Powersoft T series amplifier with DSP	6

\* See the bottom of the document for more details

## EIDOS265LA SILVER CONFIGURATION

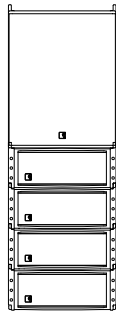

#1 FLYSUB  
#4 EIDOS265LA

FLOWN

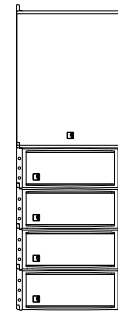

#1 FLYSUB  
#4 EIDOS265LA

OR

#1 FLYSUB  
#4 EIDOS265LA

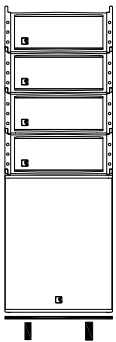

#1 T602 AMPLIFIER

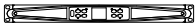

STACKED

#1 FLYSUB  
#4 EIDOS265LA

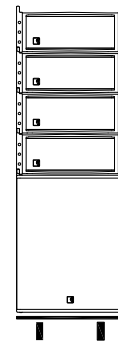

#1 T602 AMPLIFIER

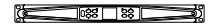

## EIDOS265LA GOLDEN CONFIGURATION

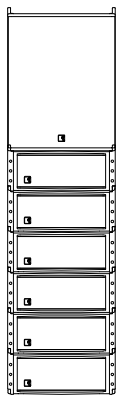

#1 FLYSUB  
#6 EIDOS265LA

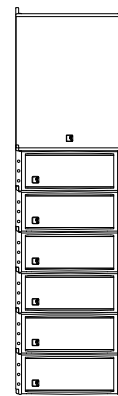

#1 FLYSUB  
#6 EIDOS265LA

#2 SUB118

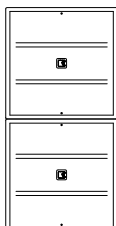

#2 T602 AMPLIFIER

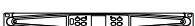
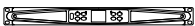

#2 SUB118



#2 T602 AMPLIFIER

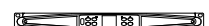
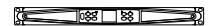

## EIDOS265LA PLATINUM CONFIGURATION

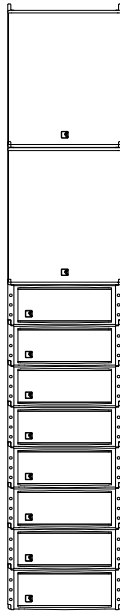

#2 FLYSUB  
#8 EIDOS265LA

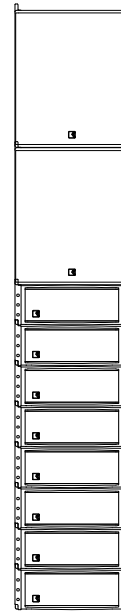

#2 FLYSUB  
#8 EIDOS265LA

#4 VEGAS24



#4 SUB118

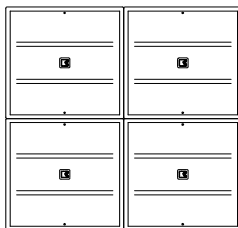

#4 SUB118

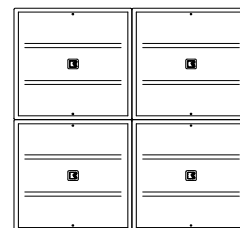

#3 T602 AMPLIFIER

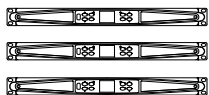

#3 T602 AMPLIFIER



## EIDOS265LA SILVER WIRING

(half system diagram)

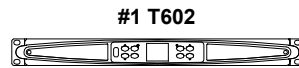
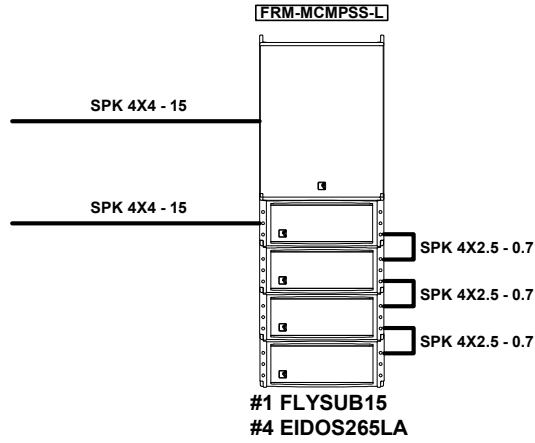

## EIDOS265LA GOLDEN WIRING

(half system diagram)

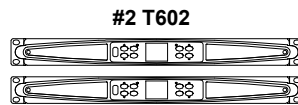
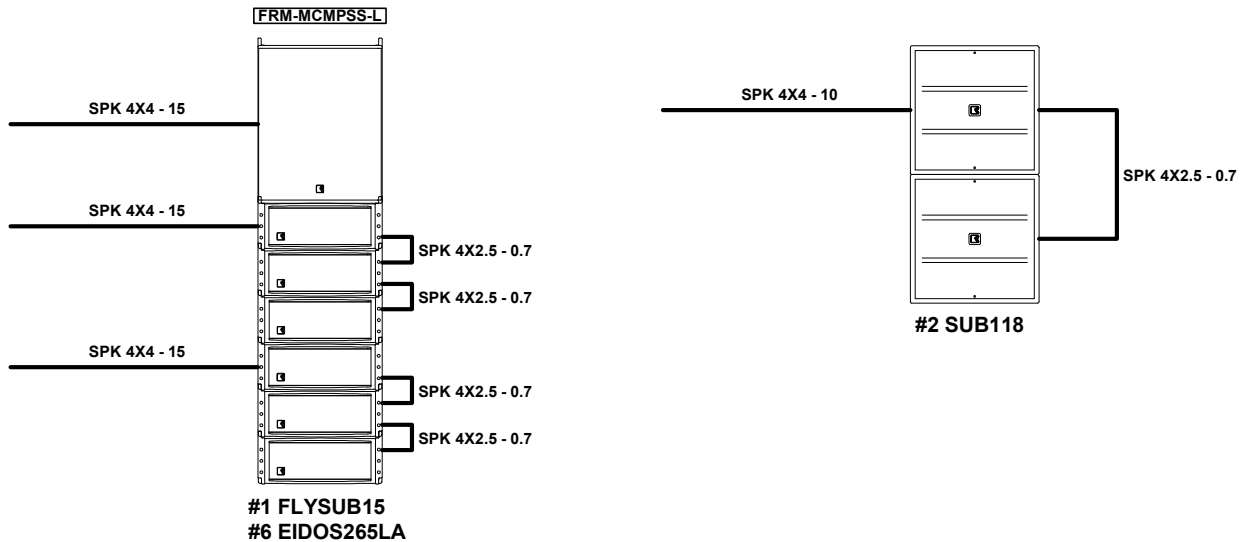



## EIDOS265LA PLATINUM WIRING

(half system diagram)

